



2021  
GRAND CANYON  
NATIONAL PARK LODGES  
BANQUET MENU

For more information please contact Group Sales  
tel. 800.843.8723  
[groups-gcsr@xanterra.com](mailto:groups-gcsr@xanterra.com)  
[grandcanyonlodges.com](http://grandcanyonlodges.com)

**GRAND CANYON**  
NATIONAL PARK LODGES  
XANTERRA TRAVEL COLLECTION



# CONTENTS

<b>AVAILABLE SPACES</b>	<b>Page 1</b>
<b>BREAKFAST</b>	<b>Page 7</b>
<b>LUNCH</b>	<b>Page 14</b>
<b>DINNER</b>	<b>Page 21</b>
<b>APPETIZERS</b>	<b>Page 33</b>
<b>RECEPTION SWEETS</b>	<b>Page 37</b>
<b>BREAKOUT ITEMS</b>	<b>Page 39</b>
<b>BEVERAGES</b>	<b>Page 41</b>
<b>CAKES</b>	<b>Page 46</b>
<b>AMENITIES</b>	<b>Page 48</b>
<b>FEES</b>	<b>Page 50</b>
<b>POLICIES &amp; PROCEDURES</b>	<b>Page 50</b>



# AVAILABLE SPACES

---

## El Tovar Dining Room

El Tovar Dining Room may be reserved for functions at the following times

### March 16 through December 1

(blackout dates may apply)

**Breakfast:** 6:30 AM to 8:00 AM (up to 60 people)

**Lunch:** 11:15 AM (up to 80 people)

**Dinner:** 4:30 PM to 5:00 PM (up to 45 people)

### December 2 through March 15

(blackout dates may apply)

**Breakfast:** 6:30 AM to 10:00 AM (up to 80 people)

**Lunch:** 11:15 AM to 2:30 PM (up to 80 people)

**Dinner:** 5:00 PM (up to 80 people)

The Food and Beverage Department must have a 30-day notice to book functions. Limit one (1) group per meal period unless approved in advance by Food and Beverage. We are unable to guarantee a specific area of the dining room. The El Tovar Dining Room is open to the public and exclusive areas may not be available. Parties of 20 or more must order in advance from the Banquet Menu.







# AVAILABLE SPACES

---

## Thunderbird Room

Located on the second floor of the Thunderbird Lodge and catered by the El Tovar's kitchen. A comfortable room with a fireplace and balcony overlooking the rim of the canyon. The room is approximately 1200 square feet.

### *Seating Capacities*

U-Shaped	Classroom	Auditorium	Family-Style
35	45	60	54
Hollow Square	Reception*	Sit-Down	
35	45	60	

## Kiva Room

Located on the first floor of the Thunderbird Lodge and catered by the El Tovar's kitchen. This room features a fireplace, a private exit to the Rim Trail, and an exquisite view of the canyon. The room is approximately 780 square feet.

### *Seating Capacities*

U-Shaped	Classroom	Auditorium
25	25	40
Hollow Square	Reception*	Sit-Down
25	52	32

\*Reception refers to standing room with very limited seating. See next page for details.

# AVAILABLE SPACES

---

## Seating Arrangements

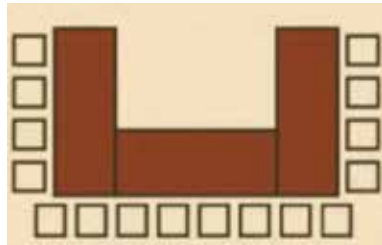

**U-Shaped**

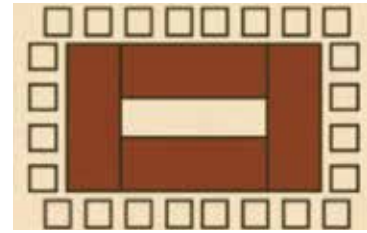

**Hollow Square**

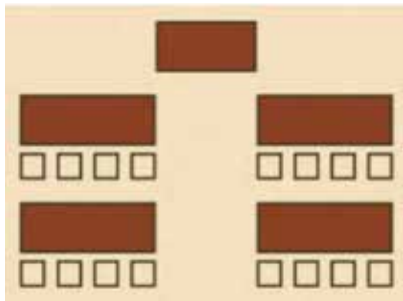

**Classroom**

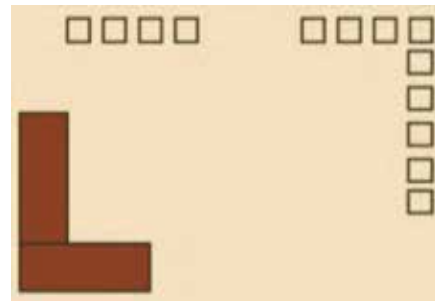

**Reception**

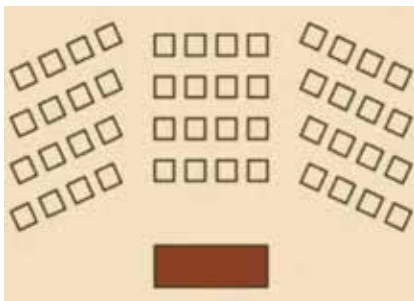

**Auditorium**

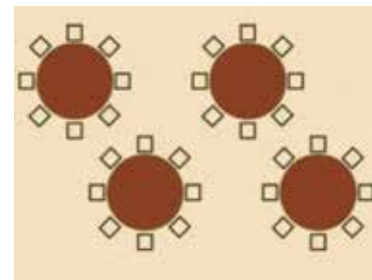

**Sit-Down**

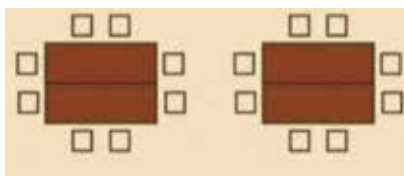

**Santa Fe Room  
Buffet Style**

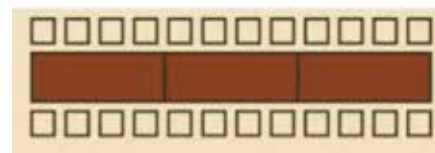

**Family-Style**



# AVAILABLE SPACES

## Thunderbird Room Wedding Floor Plans

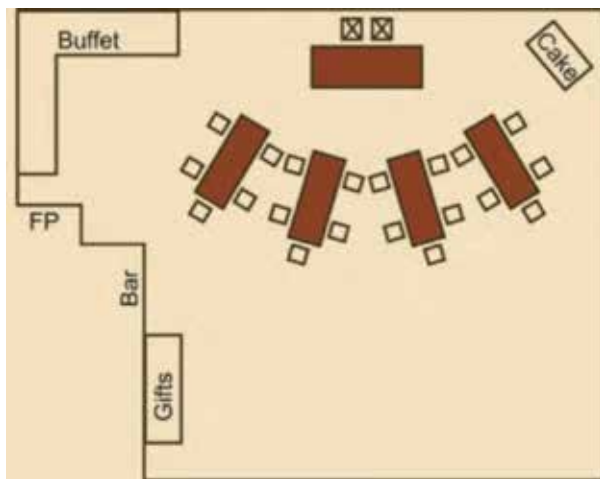

**Half Circle  
Up to 22 People**

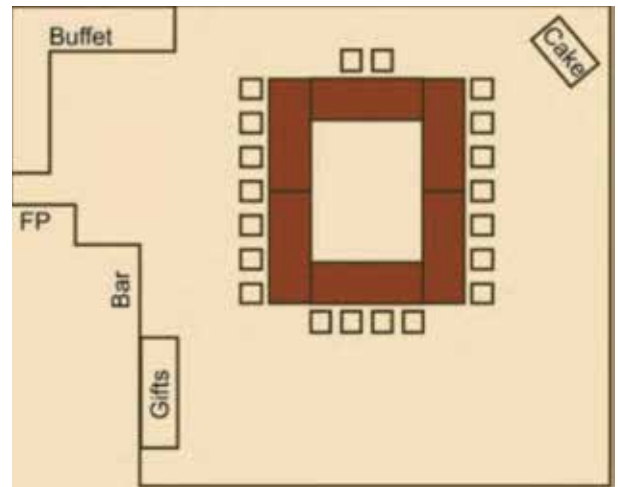

**Hollow Square  
Up to 24 People**

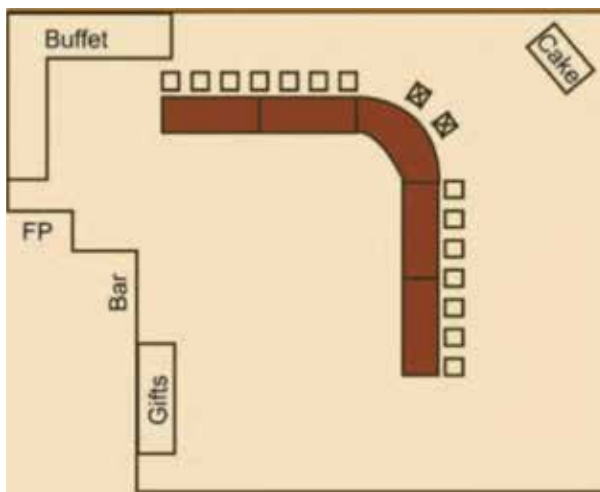

**Banquet  
Up to 34 People**

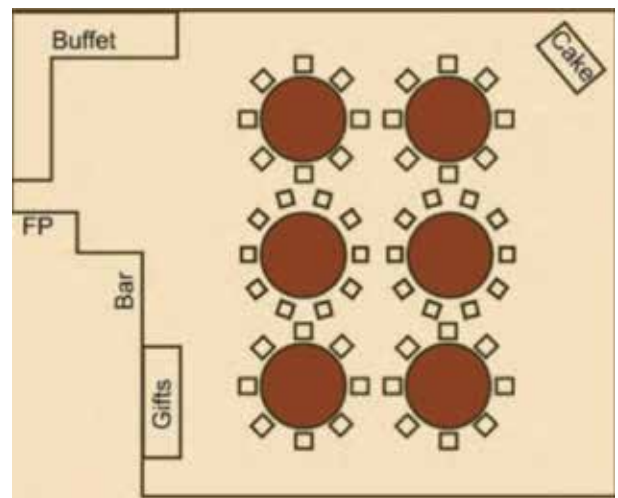

**Traditional  
Up to 52 People**

These seating charts are designed to maximize floor space. The cake and gift basket tables may be interchanged depending on group size. Orientation of the floor plans is north towards the top of this page. The canyon is to the north of all floor plans.

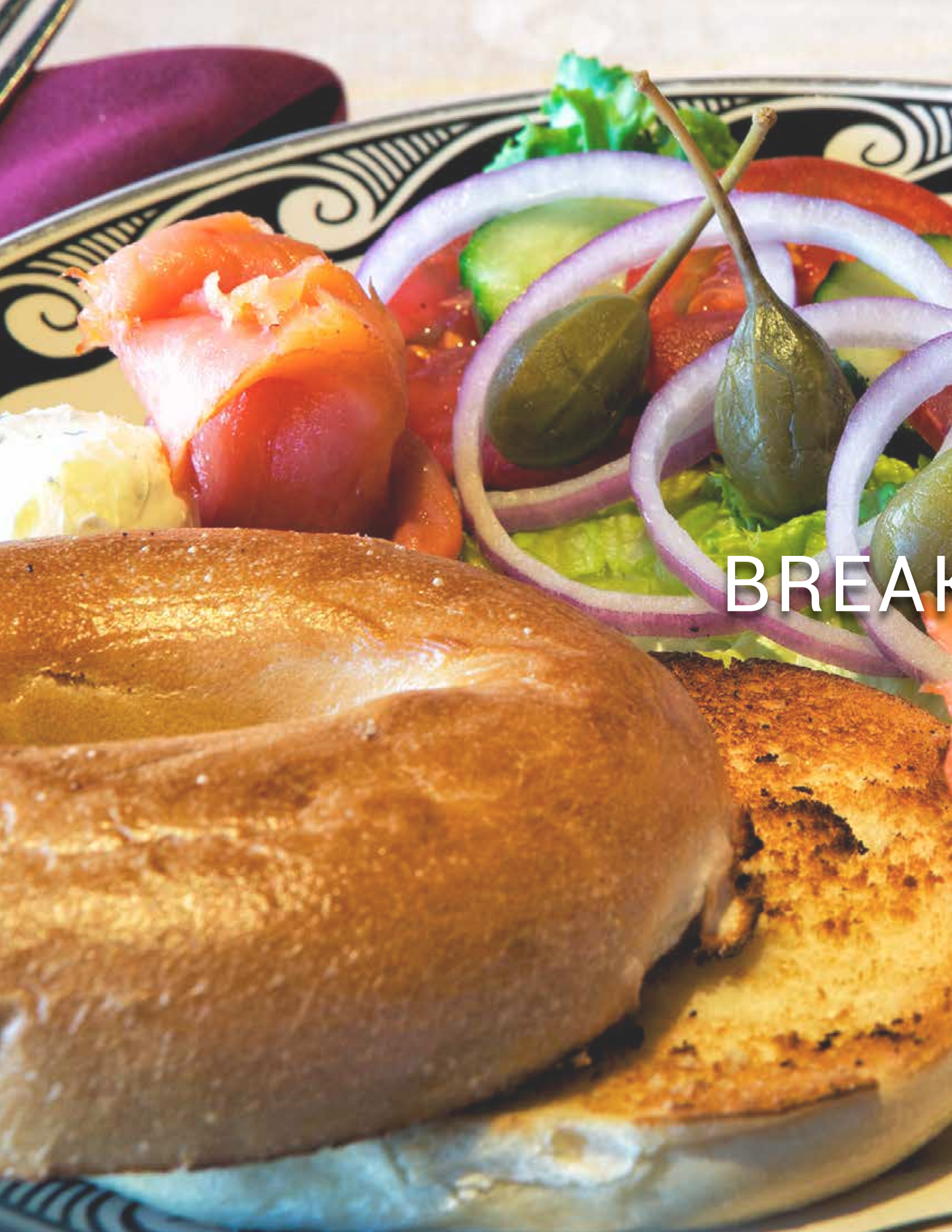

BREAK



KFAST



# BREAKFAST

---

## Thunderbird & Kiva Rooms

All include hot tea, freshly brewed regular and decaffeinated organic coffee, and orange juice. Meals catered by the El Tovar kitchen.

### Classic Breakfast Buffet – \$24.75

Scrambled Eggs with Mushrooms and Cheddar Cheese  
Roasted Red Potatoes  
Thick-Cut Cherrywood Smoked Bacon  
Fresh Fruit Salad  
Bagels with Cream Cheese

### All Inclusive Breakfast Buffet – \$22.70

**(6:30 AM - 10:00 AM)**

Assorted Cold Cereals and Granola with Milk  
Fruit Danish and Muffins  
Fresh Fruit  
Scrambled Eggs  
Thick-Cut Cherrywood Smoked Bacon  
House-made Pork Sausage  
Roasted Red Potatoes  
El Tovar Bake Shop Biscuits & Country Sausage Gravy

### Hiker's Choice Buffet – \$19.60

Assorted Breakfast Breads and/or Pastries  
Bagels with Cream Cheese  
Assorted Yogurt  
Fresh Fruit Salad  
Low-Fat Granola



# BREAKFAST

---

## El Tovar Dining Room

All include hot tea, freshly brewed regular and decaffeinated organic coffee, and orange juice.

### El Tovar Plated Breakfast – \$22.70

Scrambled Eggs with Mushrooms and Cheddar Cheese

Roasted Red Potatoes

Choice of (one selection per group):

- Thick-Cut Cherrywood Smoked Bacon
- House-made Pork Sausage

Fresh El Tovar Bakery Croissant

### El Tovar Pancake Trio – \$22.70

Blue Corn Pancake, Buttermilk Pancake, and Buckwheat Pancake (one of each)

Served with Prickly Pear Syrup

Choice of (one selection per group):

- Thick-Cut Cherrywood Smoked Bacon
- House-made Pork Sausage

### El Tovar Smoked Salmon Bagel – \$24.75

Honey Smoked Salmon

Whole Wheat Bagel

Herb Cream Cheese

### El Tovar Bakery Continental Breakfast – \$15.45

Fresh baked Danish, Muffins, and/or Croissants

Fresh Fruit Salad

# BREAKFAST

---

## Arizona Steakhouse at Bright Angel Lodge

All include hot tea, freshly brewed regular and decaffeinated organic coffee, apple juice, and orange juice.

### Arizona Steakhouse All Inclusive Breakfast – \$20.60

**(6:30 AM - 10:00 AM)**

Assorted Cold Cereals and Granola with Milk

Fruit Danish and Muffins

Fresh Fruit

Scrambled Eggs

Bacon

Sausage

Hash Browns

Biscuits & Country Gravy with Turkey Sausage

### Arizona Steakhouse Continental Breakfast – \$16.25

Assorted Cold Cereals and Granola with Milk

Fruit Danish and Muffins

Fresh Fruit Salad



# BREAKFAST

---

## Santa Fe Room at Maswik Lodge

All include hot tea, freshly brewed regular and decaffeinated organic coffee, and orange juice.

### Santa Fe All Inclusive Breakfast – \$18.55

**(6:30 AM - 10:00 AM)**

Assorted Cold Cereals and Granola with Milk

Fruit Danish and Muffins

Fresh Fruit Salad

Scrambled Eggs

Bacon

Sausage

Breakfast Potatoes

Biscuits & Country Gravy

### Santa Fe Classic Breakfast – \$16.25

Scrambled Eggs

Choice of (one selection per group):

- Bacon
- Sausage

Choice of (one selection per group):

- Breakfast Potatoes
- Oatmeal

Biscuits

Option for Assorted Fruit Yogurt (\$10.75)

### Santa Fe Continental Breakfast – \$9.30

Danish, Croissant, or Cinnamon Roll (one selection per 20 guests)

Fresh Fruit Salad

Option for Assorted Fruit Yogurt (\$10.75)

# BREAKFAST

---

## Breakfast Coupons

The following meal coupons can be purchased to allow tour guests to dine on their own. Overnight tours pick up coupons at check-in. Day tour companies may purchase coupons in advance for pick up that day at the front desk.

### **El Tovar Breakfast Coupon – \$30.10**

**(6:30 AM - 11:00 AM)**

Choice of One Entree

Choice of One Juice

Coffee or Tea

(Tax & Gratuity Included)

### **Fred Harvey Burger Breakfast Coupon – \$23.05**

**(6:30 AM - 10:45 AM)**

Choice of One Entree

Choice of One Juice

Coffee or Tea

(Tax & Gratuity Included)

### **Maswik Food Court Breakfast Coupon – \$14.50**

**(6:00 AM - 10:45 AM)**

Choice of One Entree

Choice of One Juice

Coffee or Tea

(Tax & Gratuity Included)





LUNCH

# LUNCH

---

## Thunderbird & Kiva Rooms

Available at Thunderbird Room or Kiva Room. Lunch served between 11 :00 AM and 3.00 PM. All include freshly brewed regular and decaffeinated organic coffee, lemonade, and hot or iced tea. Canned soda may be added for an additional \$3.35 per person. House-made Deluxe El Tovar Dessert may be added for an additional \$5.70 per person. Meals catered by the El Tovar kitchen.

### Western BBQ Lunch – \$32.45

Choice of one entree per person:

- Supreme Chicken Breast
- 6 oz. New York Strip Steak
- Vegan/Vegetarian Option

Cowboy Beans with Bell Peppers & Onions

Roasted Garlic Cilantro Butter Corn on the Cob

Choice of (one selection per group):

- Creamy Rustic Potato Salad with Hard Boiled Eggs
- Apple and Kale Coleslaw

Cornbread and Butter

Peach/Berry Cobbler

Plus \$51.50 Chef fee if entree is grilled on-site (available at Thunderbird Room only). To accommodate multiple entree options, group leaders must call in the count of chicken breasts, steaks, and vegan/vegetarian items to the kitchen by noon the day of arrival. For Thunderbird/Kiva, call 928.638.2526 x6432 for Advance Dinner Reservations. Fire restrictions and bad weather may prohibit the use of the outdoor grill and will be determined by the Banquet Staff the day of the event.

### Ramiro's Mexican Lunch – \$30.90

Multi-colored Tortilla Chips with Tomato Salsa

Spicy Beef Tacos

Chicken Fajitas with Peppers & Onions

Spanish Rice

Refried Beans with Cheese

Fresh Fruit Salad

El Tovar Premium Cupcakes



# LUNCH

---

## Thunderbird & Kiva Rooms

Available at Thunderbird Room or Kiva Room. Lunch served between 11 :00 AM and 3.00 PM. All include freshly brewed regular and decaffeinated organic coffee, lemonade, and hot or iced tea. Canned soda may be added for an additional \$3.35 per person. House-made Deluxe El Tovar Dessert may be added for an additional \$5.70 per person. Meals catered by the El Tovar kitchen.

### Chef's Classic Lunch – \$30.15

Field Green Salad with Selection of Three Dressings:

- Balsamic Vinaigrette
- Bleu Cheese
- House

Fresh Fruit Salad

Grilled Boneless Chicken Breast with a Choice of One Sauce:

- Lemon Pepper & Fresh Thyme
- Herb Mushroom Demi-Glace

Wild-caught Alaskan Salmon with a Choice of One Sauce:

- Seared with a Lemon Beurre Blanc & Capers
- Oven Roasted with a Honey Mustard Glaze

Chef's Choice of Two Starches and Vegetable Medley

Fresh Baked Focaccia with Butter

El Tovar Premium Cupcakes

### Deli Delight – \$27.85

Pasta Salad with Italian Dressing

Fresh Fruit Salad

New Potato Salad with Sour Cream & Fresh Dill

Deli Style Ham, Turkey, and Roast Beef

American and Swiss Cheeses

Assorted Sliced Breads (Rye, Sourdough, Wheat)

Leaf Lettuce, Sliced Tomato, Sliced Onion, Pickles

El Tovar Cookies



# LUNCH

---

## El Tovar Banquet Lunches

All include choice of one beverage per person. Beverage selections include freshly brewed regular and decaffeinated coffee, hot tea, iced tea, fountain sodas, or lemonade. House made Deluxe El Tovar Dessert may be added for an additional \$5.70 per person.

### Salmon Filet – \$32.20

7 oz. Broiled Salmon Filet with Lemon Dill Butter  
Fresh Field Greens Salad  
Chef's Choice of Accompaniments  
Fresh El Tovar Bakeshop Bread and Butter

### Roast Pork Loin – \$31.20

Roasted Pork Loin with Toasted Cumin Dijon Sauce  
Fresh Field Greens Salad  
Chef's Choice of Accompaniments  
Fresh El Tovar Bakeshop Bread and Butter

### Chicken Cordon Bleu Sandwich – \$27.85

Grilled Chicken Breast with Sliced Honey Ham, Gruyere Cheese,  
and Creamy Dijonaise Sauce  
Fresh Field Greens Salad  
Served on a Toasted Fresh El Tovar Bakeshop Ciabatta Roll

### Croissant Sandwich – \$27.05

Smoked Turkey & Peppered Bacon or Grilled Vegetables & Hummus  
Fresh Fruit Salad  
Served on a Fresh El Tovar Bakeshop Croissant

# LUNCH

---

## Santa Fe Room Lunch Buffet

Available for groups of 20 or more. Santa Fe Room at Maswik Lodge may be reserved from 11:00 AM to 11:45 AM (Blackout dates exist from Memorial Day through Labor Day).

### Santa Fe Lunch Buffet – \$20.60

Beef Entree – Either Beef Stew, Beef Tips, or Beef & Broccoli

Chef's Chicken – Either Roasted Chicken, Chicken Stir Fry, or Chicken à la King

Pasta of the Day – Either Garden Penne or Penne in Marinara

Green Salad with a Choice of Three Dressings

Assorted Cold Salads – Either Potato Salad, Four Bean Salad, or Fruit Cocktail

Soup of the Day

Chef's Choice of Potato and Rice

Vegetable of the Day

Bread and Butter

Chef's Choice Dessert

Freshly Brewed Regular & Decaffeinated Coffee, Hot or Iced Tea, Lemonade,  
Soft Drinks

# LUNCH

---

## Lunch Coupons

The following meal coupons can be purchased to allow tour guests to dine on their own. Overnight tours pick up coupons at check-in. Day tour companies may purchase coupons in advance for pick up that day at the front desk.

### **El Tovar Lunch Coupon – \$41.00**

**(11:15 AM - 2:00 PM)**

Choice of One Entree

Choice of One Dessert

Choice of One Non-Alcoholic Beverage

### **Fred Harvey Burger Lunch Coupon – \$29.00**

**(11:15 AM - 4:00 PM)**

Choice of One Entree

Choice of One Dessert

Choice of One Non-Alcoholic Beverage

### **Arizona Steakhouse Lunch Coupon – \$31.00**

**(11:15 AM - 4:00 PM)**

Choice of One Entree

Choice of One Dessert

Choice of One Non-Alcoholic Beverage

### **Maswik Food Court Lunch Coupon – \$26.00**

**(11:15 AM - 10:00 PM)**

Choice of Soup or Small Garden Salad

Choice of One Entree

Choice of One Dessert

Choice of One Non-Alcoholic Beverage

# LUNCH

---

## Meals to Go

With or without Thermal Grand Canyon souvenir bag. Packed "to go" with plasticware, napkins, and appropriate condiments.

### El Tovar Lunch – \$24.50

Croissant Sandwich with Swiss, Lettuce & Tomato  
Choice of Ham, Turkey Roast Beef, or Grilled Vegetables with Hummus  
Bag of Chips  
El Tovar Chocolate Chip Cookie  
Fresh Whole Fruit  
Sports Drink  
Without Thermal Grand Canyon souvenir bag – \$19.10

### Santa Fe Lunch – \$20.90

Sub Sandwich with Swiss, Lettuce & Tomato  
Choice of Ham, Turkey or Roast Beef  
Bag of Chips  
El Tovar Chocolate Chip Cookie  
Fresh Whole Fruit  
Sports Drink  
Without Thermal Grand Canyon souvenir bag – \$15.20

### Snack Pack – \$17.25

Snack Bar  
String Cheese  
Vegetable with Dip  
Fresh Whole Fruit  
Sports Drink  
Without Thermal Grand Canyon souvenir bag – \$11.60





DIN





NER



# DINNER

---

## Thunderbird & Kiva Rooms

Available at Thunderbird Room or Kiva Room. All include freshly brewed regular and decaffeinated organic coffee, lemonade, and hot or iced tea. Canned soda may be added for an additional \$3.35 per person. Meals catered by the El Tovar kitchen.

### Western BBQ – \$42.75

Choice of One Entree per Group:

- Supreme Chicken Breast
- 6 oz. New York Strip Steak
- Vegan/Vegetarian Option

Cowboy Beans with Bell Peppers & Onions

Roasted Garlic Cilantro Butter Corn on the Cob

Creamy Rustic Potato Salad with Hard Boiled Eggs

Apple and Kale Coleslaw

Chips & Salsa

Cornbread and Butter

Choice of House Made Deluxe El Tovar Dessert (one selection per group):

- Apple Pie
- Arizona Lime Tart
- Flourless Chocolate Cake
- Flavor of the Month Chocolate Mousse
- Boston Cream Pie
- New York Style Cheesecake with Strawberry or Blueberry topping

Plus \$19.95 Chef fee if entree is grilled on-site (available at Thunderbird Room only). To accommodate multiple entree options, group leaders must call in the count of chicken breasts, steaks, and vegan/vegetarian items to the kitchen by noon the day of arrival. For Thunderbird/Kiva, call 928.638.2526 x6432 for Advance Dinner Reservations. Fire restrictions and bad weather may prohibit the use of the outdoor grill and will be determined by the Banquet Staff the day of the event.



# DINNER

---

## Thunderbird & Kiva Rooms

Available at Thunderbird Room or Kiva Room. All include freshly brewed regular and decaffeinated organic coffee, lemonade, and hot or iced tea. Canned soda may be added for an additional \$3.35 per person. Meals catered by the El Tovar kitchen.

### Chef's Classic Dinner – \$38.65

Choice of Field Green Salad with Selection of Three Dressings:

- Balsamic Vinaigrette
- Bleu Cheese
- House

Or Caesar Salad with Garlic Croutons

Fresh Fruit Salad

Grilled Boneless Chicken Breast with a Choice of One Sauce:

- Lemon Pepper & Fresh Thyme
- Herb Mushroom Demi-Glace

Wild-caught Alaskan Salmon with a Choice of One Sauce:

- Seared with a Lemon Beurre Blanc & Capers
- Oven Roasted with a Honey Mustard Glaze

Chef's Choice of Two Starches and Vegetable Medley

Fresh Baked Focaccia with Butter

Choice of House Made Deluxe El Tovar Dessert (one selection per group)

- Apple Pie
- Arizona Lime Tart
- Flourless Chocolate Cake
- Flavor of the Month Chocolate Mousse
- Boston Cream Pie
- New York Style Cheesecake with Strawberry or Blueberry topping

### Ramiro's Mexican Dinner – \$34.00

Multi-colored Tortilla Chips with Tomato Salsa

Spicy Beef Tacos and Burritos

Spanish Rice

Refried Beans with Cheese

Fresh Fruit Salad

Choice of House Made El Tovar Dessert

# DINNER

---

## El Tovar Banquet Dinners

All include choice of one beverage and one dessert per person. Beverage selections include freshly brewed regular and decaffeinated organic coffee, hot tea, iced tea, fountain soda, or lemonade. House made Deluxe El Tovar Dessert included (one selection per group; listed on next page).

### Filet Mignon – \$58.20

Fresh Field Greens Salad with House Balsamic Vinaigrette  
6 oz. Filet Mignon with Au Poivre Sauce  
Chef's Choice of Accompaniments  
Fresh El Tovar Bakeshop Bread & Butter

### Wild Caught Salmon – \$53.30

Fresh Field Greens Salad with House Balsamic Vinaigrette  
Seared Wild Caught Salmon with Lemon Dill Butter  
Chef's Choice of Accompaniments  
Fresh El Tovar Bakeshop Bread & Butter

### Chef's Prime Rib – \$53.30

Fresh Field Greens Salad with House Balsamic Vinaigrette  
8 oz. Oven Roasted Prime Rib with Chipotle Butter  
Chef's Choice of Accompaniments  
Fresh El Tovar Bakeshop Bread & Butter

### Blackened Trout with Citrus Butter – \$47.65

Fresh Field Greens Salad with House Balsamic Vinaigrette  
Chef's Choice of Accompaniments  
Fresh El Tovar Bakeshop Bread & Butter

# DINNER

---

## El Tovar Banquet Dinners

All include choice of one beverage and one dessert per person. Beverage selections include freshly brewed regular and decaffeinated organic coffee, hot tea, iced tea, fountain soda, or lemonade. House made Deluxe El Tovar Dessert included (one selection per group; listed on next page).

### Prickly Pear Chicken Breast – \$42.25

Fresh Field Greens Salad with House Balsamic Vinaigrette  
Marinated Boneless Chicken Breast  
Topped with Peppers, Onions, and Pepper Jack Cheese  
Chef's Choice of Accompaniments  
Fresh El Tovar Bakeshop Bread & Butter

### Portabella Mushroom – \$25.75

Portabella Mushroom  
Artichoke, Tomato, Onion, Bell Pepper, Spinach Stuffing  
Red Pepper Coulis  
Wild Rice Wheat Berry Pilaf

## House Made Deluxe El Tovar Desserts

Apple Pie

Chocolate Mousse

Arizona Lime Tart

Boston Cream Pie

Flourless Chocolate  
Cake

New York Style Cheesecake  
with Strawberry or  
Blueberry Topping



# DINNER

---

## Santa Fe Room Dinner Buffets

All include choice of one beverage and one dessert per person. Beverage selections include freshly brewed regular and decaffeinated organic coffee, hot tea, iced tea, fountain soda, or lemonade.

### Santa Fe Dinner Buffet – \$25.75

Beef Entree

(Either Beef Stew, Beef Stroganoff, or Beef and Broccoli)

Chef's Chicken

(Either Roasted Chicken, Chicken Stir Fry, or Chicken à la King)

Pasta of the Day

(Either Garden Penne or Penne in Marinara)

Green Salad with Choice of Three Dressings

(Balsamic Vinaigrette, Bleu Cheese, House)

Potato Salad

Three Bean Salad

Fruit Cocktail

Soup of the Day

Chef's Choice of Potato and Rice

Vegetable of the Day

Bread & Butter

Chef's Choice of Dessert

### A Taste of Italy – \$27.85

Tossed Green Salad with Selection of Three Dressings

(Balsamic Vinaigrette, Bleu Cheese, House)

Choice of Two Entrees:

- Baked Eggplant Parmigiana
- Tortellini with Pesto Alfredo
- Baked Penne Parmigiana
- Sweet Sausage & Peppers with Spaghetti
- Spaghetti Meatballs

Garden Vegetables Tossed in Olive Oil

Sliced Italian bread

Choice of House Made Deluxe El Tovar Dessert

27 (one selection per group, see next page for selections)

Price for all items listed per serving/person. All prices are in USD. Subject to 6.9% sales tax and 18% gratuity. Pricing subject to change. Menu items may contain nuts and nut by-products – please advise of any allergies or intolerances.

# DINNER

---

## Santa Fe Room Dinner Buffets

All include choice of one beverage and one dessert per person. Beverage selections include freshly brewed regular and decaffeinated organic coffee, hot tea, iced tea, fountain soda, or lemonade.

### Canyon Classic – \$35.80

Choice of Field Green Salad with Selection of Three Dressings

(Balsamic Vinaigrette, Bleu Cheese, House)

or Caesar Salad with Garlic Croutons

Fresh Fruit Salad

Grilled Chicken Breast with a Mushroom Demi-Glace

Wild Caught Salmon Seared with a Lemon Beurre Blank and Capers

Chef's Choice of Two Starches and Vegetable Medley

Fresh Baked Focaccia with Butter

Choice of House Made Deluxe El Tovar Dessert

(one selection per group)

## House Made Deluxe El Tovar Desserts

Apple Pie

Chocolate Mousse

Arizona Lime Tart

Boston Cream Pie

Flourless Chocolate  
Cake

New York Style Cheesecake  
with Strawberry or  
Blueberry Topping

# DINNER

---

## Santa Fe Room Dinner Buffets

All include choice of one beverage and one dessert per person. Beverage selections include freshly brewed regular and decaffeinated organic coffee, hot tea, iced tea, fountain soda, or lemonade.

### Canyon BBQ – \$42.75

Choice of One Entree per Group:

- Supreme Chicken Breast
- 6 oz. New York Strip Steak
- Vegan/Vegetarian Option

Ranch Beans

Corn on the Cob

Potato Salad

Coleslaw

Chips & Salsa

Cornbread and Butter

Choice of House Made Deluxe El Tovar Dessert (one selection per group):

- Apple Pie
- Arizona Lime Tart
- Flourless Chocolate Cake
- New York Style Cheesecake with Strawberry or Blueberry topping

Plus \$51.50 Chef fee if entree is grilled on-site. To accommodate multiple entree options, group leaders must call in the count of chicken breasts, steaks, and vegan/vegetarian items to the kitchen by noon the day of arrival. For Santa Fe Room, call 928.638.2526 x6887. Ask for the manager on duty. Fire restrictions and bad weather may prohibit the use of the outdoor grill and will be determined by the Banquet Staff the day of the event.



# DINNER

---

## Santa Fe Room Plated Banquet Dinners

All include freshly brewed regular and decaffeinated organic coffee, hot or iced tea, fountain sodas, and lemonade. Each dinner also includes House Made Deluxe El Tovar Desserts – Apple Pie, Arizona Lime Tart, Flourless Chocolate Cake, New York Style Cheesecake with Strawberry or Blueberry Topping (one selection per group).

### Prime Rib – \$38.90

Tossed Green Salad  
8 oz. Roast Prime Rib of Beef with Mushroom Demi-Glace and Horseradish Cream  
Potato of the Day  
Vegetable of the Day  
Rolls & Butter

### Sautéed Trout with Lemon Butter – \$30.65

Tossed Green Salad  
Sautéed Trout with Lemon Dill Butter  
Rice of the Day  
Vegetable of the Day  
Rolls & Butter

### Pork Loin – \$30.65

Tossed Green Salad  
Sliced Pork Loin with Dijon Mustard Sauce  
Rice of the Day  
Vegetable of the Day  
Rolls & Butter

### Beef Stroganoff – \$26.55

Tossed Green Salad  
Beef Tips with Onions & Mushrooms in a Sour Cream Sauce  
Rice of the Day  
Vegetable of the Day  
Rolls & Butter

# DINNER

---

## Chef & Carving Stations

Available at the Thunderbird, Kiva, and Santa Fe Rooms. For accompaniments, ask your Sales Agent. 20 person minimum for all stations. Each station requires a Chef (\$51.50 fee per station).

### Pasta Station – \$23.20

A beautiful display of pasta featuring the following:

- Tri-Color Cheese Tortellini
- Angel Hair Pasta
- Spinach Fettuccine Pasta
- Meatballs
- Marinara Sauce
- Alfredo Sauce
- Pesto Sauce

Without Meatballs (\$19.35)

### Dijon Herb Crusted Strip Loin of Beef – \$17.55

With Horseradish Cream and Au Jus  
Served with Cocktail Rolls

### Herb Crusted Roast Beef – \$11.35

With Horseradish Cream and Au Jus  
Served with Cocktail Rolls

### Buffet Ham – \$10.30

With Honey Mustard Glaze, Horseradish Cream, Mayonnaise,  
and Assorted Mustards  
Served with Cocktail Rolls

# DINNER

---

## Dinner Coupons

The following meal coupons can be purchased to allow tour guests to dine on their own. Overnight tours pick up coupons at check-in. Day tour companies may purchase coupons in advance for pick up that day at the front desk.

### El Tovar Dinner Coupon – \$77.05

**(5:00 PM - 9:45 PM)**

Choice of Soup or Salad

Choice of One Entree

Choice of One Dessert

Choice of One Non-Alcoholic Beverage

### Fred Harvey Burger Dinner Coupon – \$43.90

**(4:30 PM - 10:00 PM)**

Choice of Soup or Salad

Choice of One Entree

Choice of One Dessert

Choice of One Non-Alcoholic Beverage

### Arizona Steakhouse Dinner Coupon – \$61.00

**(4:30 PM - 10:00 PM)**

Choice of Soup or Salad

Choice of One Entree

Choice of One Dessert

Choice of One Non-Alcoholic Beverage

### Maswik Food Court Dinner Coupon – \$26.00

**(4:30 PM - 10:00 PM)**

Choice of Soup or Salad

Choice of One Entree

Choice of One Dessert

Choice of One Non-Alcoholic Beverage





APPET



TIZERS



# APPETIZERS

---

## Hot Appetizers

All appetizers include approximately one-and-a-half items per serving unless otherwise noted.

**Teriyaki Glazed Beef Skewers – \$4.65**

**Teriyaki Glazed Chicken Skewers – \$4.65**

**Miniature Mexican Appetizers – \$6.70**

1 of each of the following per serving:

- Tacos
- Taquitos
- Burritos with Fresh Tomato Salsa

**Buffalo Chicken Wings with Bleu Cheese Dip – \$2.10**

## Cold Appetizers

All appetizers include approximately one-and-a-half items per serving unless otherwise noted.

**Smoked Salmon on Toasted Points – \$5.15**

**Gulf Shrimp with Horseradish Cocktail Sauce – \$4.65**

**Duck Pâté on Toasted Points – \$6.70**

Served with Wild Berry Garnish

**4 oz. Fresh Salsa with Tortillas – \$5.15**

Choice of Tomato, Tomatillo, Roasted Corn, or Black Bean Salsas

**4 oz. Spinach & Artichoke Dip – \$5.15**

Choice of Tomato, Tomatillo, Roasted Corn, or Black Bean Salsas

# APPETIZERS

---

## Cold Appetizer Platters

All appetizers include approximately one-and-a-half items per serving unless otherwise noted.

### **Deli Platter – \$13.15**

Deli Sliced Roast Beef, Turkey, and Ham  
Swiss and American Cheeses  
Assorted Breads

### **Imported Cheese Platter – \$9.00**

Smoked Gouda, Brie, Edam, Gorgonzola, Cheddar, Swiss,  
Pepper Jack, and Munster Cheeses  
Assorted Crackers

### **Domestic Cheese Platter – \$7.75**

Cheddar, Swiss, Pepper Jack, and Munster Cheeses  
Assorted Crackers

### **Fresh Fruit Platter – \$8.00**

Fresh Seasonal Fruit (5 oz. per serving)

### **Vegetable Crudités Platter – \$6.95**

Red & Green Bell Peppers, Broccoli Florets, Celery, Carrots,  
and Cucumbers with Herb Dip (5 oz. per serving)





# RECEPTION SWEETS



# RECEPTION SWEETS

---

## **Tuxedo Strawberries – \$7.95**

Stemmed Strawberries Dipped in Melted White and Dark Chocolate

## **Chef's Choice of Assorted Petit Fours – \$5.15**

Three items per serving

## **Chef's Choice of Assorted Hand Made Truffles – \$4.90**

Five items per serving:

- Chocolate
- White Chocolate Mango
- Dark Chocolate Rum

The following reception sweets require a 20 person minimum and have an additional \$51.50 Rental/Chef's Fee.

## **Bananas Foster – \$12.90**

Bananas flambéed in the traditional manner with Dark Rum

Brown Sugar Butter

Cinnamon

Served over Vanilla Ice Cream

## **Cherries Jubilee – \$12.90**

Tart Cherries blended with Orange Juice and Kirshwasser Brandy then flambéed

Served over Vanilla Ice Cream

## **Chocolate Fountain – \$8.25**

7.5 pieces per person

Choice of up to 5 of the following:

- Whole Strawberries
- Pineapple Slices
- Banana Slices
- Marshmallows
- Pretzels
- Pound Cake Squares
- Oreo Cookies
- Rice Krispy Treats
- Chocolate Chip Cookies
- Brownies





# BREAKOUT ITEMS



# BREAKOUT ITEMS

---

## Continental Breakfast – \$12.40

Fresh Banana Bread  
Assorted Mufins  
Croissants  
Pastries  
Select Hot Teas  
Freshly Brewed Regular and Decaffeinated Organic Coffee

## A la Carte Items

House Made Mini Pastries, Muffins, or Croissants (per piece) – \$6.20  
Fruit Danish, Muffins, or Cookies (per piece) – \$2.85  
Assorted Whole Fresh Fruit (per piece) – \$3.90  
Assorted Large El Tovar Cookies (per dozen) – \$20.35  
Select Hot Teas – \$4.40  
Freshly Brewed Regular and Decaffeinated Organic Coffee – \$4.40  
Iced Tea – \$3.35  
Soda (per can) – \$3.65  
Sports Drink (per bottle) – \$4.65  
Milk – \$4.65  
El Tovar Orange Juice – \$5.40  
El Tovar Juice – \$5.40  
Lemonade – \$3.35  
Hot Chocolate (per packet) – \$2.85



# BEVERAGES



# BEVERAGES

---

## Thunderbird Room Liquor for Functions

Premium Bar is available in the Thunderbird Room only and is also stocked with assorted sodas.

### Price Range

Single Shot or with Mixer:

- Well – \$9.30
- Call – \$10.30

Two Part Drinks:

- Well – \$10.30
- Call – \$11.50

Courvoisier, B&B, and Grand Marnier – \$12.40

### Pre-Mixed Drinks

All Mixed Drinks are priced for House Well Liquors. 32 ounce serving (approximately five servings).

Bloody Mary – \$35.00

Margaritas – \$37.10

White Wine Pineapple Sangria – \$37.10

Traditional Sangria – \$37.10

### Deposit Schedule for Bar Set Up

Functions up to 50 People – \$412

Functions between 51-75 People – \$721

Functions between 76-100 People – \$824

Functions over 100 People – \$1030



# BEVERAGES

---

## Wine & Beer

The following are the brands that are served at a function requesting a wine & beer bar only.

### Grand Canyon Label Varietals

Each bottle serves five to six glasses.

#### Sparkling:

Prosecco, Italy – \$38.00

Grand Canyon Sparkling, California – \$37.00

#### Other Whites:

Pinot Grigio, Grand Canyon Private Label, California – \$37.00

Conundrum White Blend, California – \$43.00

Sauvignon Blanc, Oyster Bay, New Zealand – \$46.00

#### Chardonnay:

Grand Canyon Private Label, California – \$37.00

Rodney Strong, Chalk Hill, California – \$48.00

Sonoma Cutrer, Russian River Ranches, California \$59.00

#### Pinot Noir:

Irony, Monterey, California – \$43.00

Erath, Oregon, Washington, Oregon – \$55.00

#### Cabernet:

Grand Canyon Private Label, California – \$37.00

Arizona Stronghold, Arizona – \$50.00

Louis Martini, Napa Valley, California – \$77.00

#### Other Reds:

Purple Heart, Red Blend, California – \$43.00

Any Grand Canyon Label Varietals by the Glass – \$8.25

### Domestic and Premium Beers

Served by the can.

Coors Light – \$7.25

O'Doul's Non-Alcoholic – \$7.25

Heineken – \$8.25

Modelo – \$8.25

16 Ounce Draught Beers (Thunderbird and Santa Fe Rooms Only)

Grand Canyon Pilsner – \$8.25

Mother Road Tower Station IPA – \$8.25

# BEVERAGES

---

## Punch & Sangria

One gallon serves approximately 15 to 20 servings.

### **Strawberry Lemonade Champagne Punch – \$67.00/gallon**

Grand Canyon Label Sparkling Wine

Fresh Strawberries

Lemonade

Sugar

### **Sorbet Champagne Punch – \$67.00/gallon**

Grand Canyon Label Sparkling Wine

Pineapple Juice

Lemon Juice

Berry Sorbet

### **Non-Alcoholic Sparkling Fruit Punch – \$37.00/gallon**

Ginger Ale

Pineapple Juice

Berry Sorbet

Garnished with Fresh Fruit

### **White Wine Pineapple Sangria – \$37.00/half gallon**

Grand Canyon Label Chardonnay

Ginger Ale

Apple and Lemon Juices

Pineapple Juice

Garnished with Fresh Pineapple

### **Traditional Sangria – \$37.00/half gallon**

Grand Canyon Label Cabernet Sauvignon

Brandy

Lemon Juice

Orange Juice

Garnished with Fresh Fruit



# BEVERAGES

---

## Non-Alcoholic Beverages

All prices listed are per person unless otherwise noted.

### Thunderbird or Kiva Rooms

Freshly Brewed Regular or Decaffeinated Organic Coffee – \$4.40

Hot Tea – \$3.90

Iced Tea – \$3.35

Soda (per can) – \$3.65

Sports Drink (per bottle) – \$4.65

Milk – \$4.15

El Tovar Fresh Orange Juice – \$5.40

El Tovar Fresh Grapefruit Juice – \$5.40

Lemonade – \$3.90

Hot Chocolate (per packet) – \$3.65

### Santa Fe Room

Freshly Brewed Regular or Decaffeinated Organic Coffee – \$3.35

Hot Tea – \$3.35

Iced Tea – \$3.10

Fountain Soda and Lemonade – \$2.85

Sports Drink (per bottle) – \$3.90

Milk (carton) – \$3.10

Orange, Apple, or Cranberry Juice – \$5.40

El Tovar Fresh Grapefruit Juice – \$3.65

Hot Chocolate (per packet) – \$3.65



# CAKES

# CAKES

---

## Special Occasion Cakes

All cakes must be purchased through Xanterra South Rim in order to be served on the premises. Any cake ordered less than one week prior to event must be approved by the Pastry Chef. Please contact the Sales Office during normal business hours to place your order at 928.638.2525. Damaged or lost items subject to 100% replacement fee. All cakes are house made.

### Basic Cake Pricing

All cakes are two layers

- 6" Round x 4" Tall (serves six) – \$40.00
- 8" Round x 4" Tall (serves 10-12) – \$60.00
- 10" Round x 4" Tall (serves 14-18) – \$85.00
- 12" Round x 4" Tall (serves 25-28) – \$108.00
- 14" Round x 4" Tall (serves 40) – \$136.00
- 1/2 Sheet (17" x 13" x 4") (serves 50) – \$96.00
- Full Sheet (25" x 17" x 4") (serves 100) – \$160.00

### Additional Charges

- Delivery and Set Up within Grand Canyon Village – \$42.00
- Chef's Fee for Cake Cutting – \$26.00
- Chocolate Ganache (per tier) – \$19.00
- Tiered Cake Delivery and Set Up – \$130.00

Intricate piping, edible pearls, edible glitter, chocolate modeling, or logos will be determined upon consultation with Pastry Chef.

Tiered cakes require 4" variation on tiers (16" - 12" - 8") (14" - 10" - 6")

### Wedding Cakes Only

Cake Toppers must be delivered to bake shop one day prior to the event. If fresh flowers are to be used as a topper, they must be arranged and ready to place on cake. Fresh flowers accompanying cake and cake table must be delivered to the bake shop no later than 8 AM the day of the event.

### Cupcakes

- 2" – \$3.10 each
- 4" – \$5.15 each



# AMENITIES



# AMENITIES

---

All amenities are available at all Xanterra South Rim locations. Baskets are prepared for two guests. Wine may be added to baskets.

## **El Tovar VIP Fruit & Cheese – \$65.00**

Assorted Whole Fresh Fruit and Grapes  
Fruit and Nut Mix  
River Rock Candy  
Gourmet Cheeses with Cheese Knife  
Fancy Crackers  
El Tovar Cookies  
Presented with the Story of the El Tovar Hotel

## **Standard Fruit & Cheese – \$38.00**

Assorted Whole Fresh Fruit and Grapes  
Gourmet Cheeses  
Fancy Crackers  
El Tovar Cookies

## **Wine Addition Prices**

Any wine from the El Tovar Wine List may be added for an additional \$2.00 service charge (prices listed per bottle).

Grand Canyon Varietals – \$37.00  
Grand Canyon Sparkling Wine – \$37.00  
El Tovar Centennial Pinot Gris – \$45.50  
El Tovar Centennial Pinot Noir – \$52.50

## **Chocolate Delight – \$18.50**

Hand-molded Dark Chocolate Box filled with  
Assorted House Made Chocolate Truffles

# ROOM RENTAL & SET UP FEES

---

## **Banquet Room Use**

Price listed per meal period. Taxes included.

Applicable to Thunderbird Banquet Room (includes sound system) – \$206

Applicable to Kiva Banquet Room – \$103

## **Banquet Room Set Up**

Charged in addition to the Banquet Room Use Fee per day.

Applicable to all events requiring set up without food purchase – \$77.00

## **El Tovar Guest Room Set Up**

Only applicable to El Tovar guest room set up of any items other than room service and in addition to food – \$77.00

## **Food Delivery & Set Up**

Applicable to food or beverages delivered to locations other than Xanterra outlets in Grand Canyon Village. Includes chafing dishes, beverage dispensers, and utensils. – \$206

Shoshone Point China – \$412

Shoshone Point Paper & Plastic – \$206

## **Food Delivery & Set Up**

Applicable to food or beverages delivered to locations within Grand Canyon Village (Meals to Go). – \$77.00

# ROOM RENTAL & SET UP FEES

---

## **Non Xanterra Site Set Up – \$5.15/person**

Transportation and set up of supplies and services including china, glassware, silverware, and linens.

## **Banquet Table Rental – \$10.00/table per day**

## **Banquet Chair Rental – \$2.00/chair per day**

## **Premium Bar Set Up – \$155**

Thunderbird and Kiva Rooms only. Premium Banquet Bar includes ice mixers, glassware, and Bartender.

## **Wine & Beer Bar Set Up (On-Site) – \$77.00**

Wine and beer only (no charge for Thunderbird Room). Includes ice mixers, glassware, and Bartender.

## **Wine & Beer Bar Set Up (Off-Site) – \$130.00**

Wine and beer only (no charge for Thunderbird Room). Includes ice mixers, glassware, and Bartender.

## **Chef Fee – \$130.00/Chef**

Applicable to on-site preparation, i.e. carving station, pasta bar, barbecue.

## **Fireplace Use – \$52.00/four hours**

Thunderbird and Kiva Rooms only. Weather permitting.

# ROOM RENTAL & SET UP FEES

---

## **Dance Floor – \$206**

Santa Fe Room at Maswik Lodge only.

## **Sound System – \$103/meal period**

Fender Sound System with CD Player, Microphone, MP3 ready

## **Audio Visual Flat Rate – \$155/day**

Applies to any audio visual equipment requested. Available AV equipment includes Portable Bluetooth-enabled MP3 Player, and Projector. Extension cords provided. Damaged items subject to minimum 50% replacement fee.

## **Flip Chart Pads – \$47.00/pad**

## **Post It Note Pads – \$21.00/pad**

## **Podium, Screen, Easels – \$26.00/day**

## **LCD Projector Package – \$103**

## **Pop Up Canopy – \$52.00/four hours**

Weather permitting. 10' x 10' and includes set up.



# POLICIES & PROCEDURES

---

## Food & Beverage

- No personal food or beverage may be brought into any banquet facility at any time.
- All banquet options, group functions and dining facilities are subject to health and safety guidelines/restrictions and may change without notice.
- A minimum of 20 people or 20 meals/servings is required to book any function space.
- Finalized menu selections must be received 30 days prior to the event.
- A minimum of 20 same menu entrees per group required.
- Confirmed attendance must be provided at least three business days prior to the event.
- Full payment for services is due no later than 30 days prior to arrival. The only exception are items sold "by consumption." Groups booked less than 30 days prior to arrival must make payment by the date stated on the Group Agreement.
- Full event cancellations must be made in writing at least 30 days prior to the event date to receive a full refund.
- Any and all services may be refused and payment forfeited if the group is 30 minutes or more late.
- Any damage to property or loss of Xanterra South Rim revenue caused by the group will be the responsibility of the group or booking party.
- Applicable fees for room rental and special services will be applied to all functions or events. These charges are listed under Banquet Set Up Fees (complete banquet information is in the Group Services section on our website ([grandcanyonlodges.com](http://grandcanyonlodges.com))).
- All banquet facilities are non-smoking.
- Special dietary requests come with an additional \$8.00 per person per meal fee.
- Quiet hours for Thunderbird and Kiva Rooms begin at 9:30 PM (MST). All parties must vacate the premises by 10:00 PM. Quiet hours for Santa Fe Room at Maswik Lodge begin at 10:00 PM (MST). All parties must vacate the premises by 10:30 PM.
- All food items and services are subject to current sales tax of 6.9% and 18% gratuity (subject to change without notice).
- We reserve the right to relocate any group to an alternate Xanterra location within the park based on group number, menu requirements, feasibility of event, safety, or weather concerns.

# POLICIES & PROCEDURES

---

## Food & Beverage (cont.)

- Any decorations, equipment, packages, or materials must be delivered prior to the event and prearranged with the Sales Office. Xanterra South Rim does not accept any liability for these items.
- All displays, exhibits, banners, decorations, signs and other similar items must conform to Fire Ordinances. Placement of such items must be approved in advance by the Banquet Staff.
- Xanterra South Rim reserves the right to require security services for some events. Payment for such services will be the responsibility of the group or customer hosting the function.
- Disturbances: Should Security be called to the event, one warning at any time will be excused. If a second warning is required, the premises must be vacated immediately and no refunds will be issued. Should the disturbance cause a room guest to request a refund, the cost of the room will become the responsibility of the group or booking party.

## Alcoholic Beverage Service

- Only alcohol purchased from Xanterra South Rim may be consumed on the premises during the banquet event. The guest may not bring their own alcohol onto the premises under any circumstances during the banquet event. Alcoholic beverages may not be removed from the premises.
- Xanterra South Rim will special order items that we do not carry in our commissary. The special items will be subject to availability and will require a 30-day advance notice. Price will be determined by item. Special orders are non-refundable.
- ALL guests consuming alcohol on the premises must be 21 years of age and present proof of age when requested by our staff.
- The following forms of identification are the ONLY accepted forms of legal identification and all forms must include a photo. No exceptions to this policy will be made. Any US or Canadian Driver's License; Any US or Canadian Identification Card; Valid Passport or Passport Card; Military ID; Mexican Voter ID.
- We reserve the right to refuse service to anyone at any time as determined by our staff.
- No liquor may be served before 6:00 AM (MST). All liquor sales must be complete by 9:30 PM (MST) at the Thunderbird and Kiva Rooms and the Santa Fe Room.
- Any violation of the above regulations will result in termination of the event.
- These regulations are stated in the State of Arizona Liquor Code and may not be waived for any reason.

# KIDS' MENU

---

## Plated

All Kid's Menu items come with a Kid's Beverage

**For Kids 3-10 Years Old – \$17.80 (inclusive)**

Hot Dog with French Fries

Chicken Tenders with French Fries

Child's Hamburger with French Fries

Mac 'N' Cheese with Fresh Fruit



